

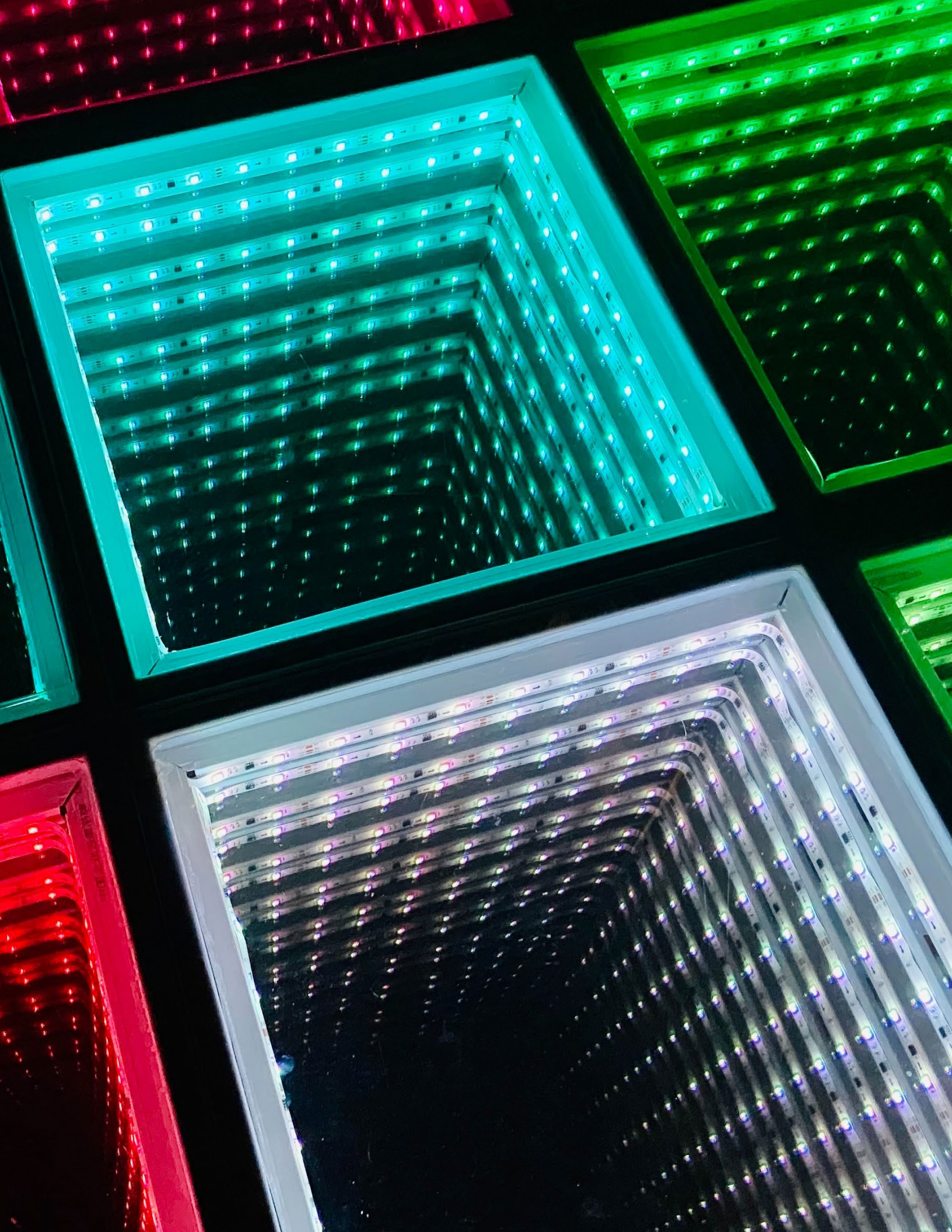

2022
**LED Strip Light
Catalog**



SARIN's Quality



QUALITY OF LIGHT

Without light it would be impossible to view the world around us. Light illuminates objects for us to see, and the spectrum emitted by a light source provides colors in these objects. Variants of color offer advantages for different lighting applications. We use several tools such as Kelvin, CCT, and CRI to determine characteristics and quality of light.

The Correlated Color Temperature Scale

The Kelvin based CCT (Correlated Color Temperature), is a scale in lighting to measure the color temperature of a light. It puts specifics to the description of the appearance of white lights such as warm, neutral, or cool.

The color chosen for an application may vary based on the use of the space and the material illuminated. For example, warmer lights are very popular in residential applications, while cooler lights are more prevalent in commercial and industrial spaces.

Correlated Color Temperature (CCT) Light Range Comparison Chart



Quality Makes All The Difference

With the development of LED technology the quality of electric light has been changed forever. LED sources illuminate objects for us to see and now feel the full range of colors within these objects. New lighting technology takes advantage of a wide variety of colors to meet your application needs.

Color Rendering Index

A color rendering index (CRI) is the most useful measure of a color characteristic of a light source. CRI is the measure of the ability of a light source to reveal the color of various objects faithfully in comparison with an ideal or natural light source like the sun (CRI 100). To avoid under or over saturated objects and muted colors, CRI must be in a range of 80-98 especially in retail, food, and art environments making surfaces appear colorful, vibrant and natural.

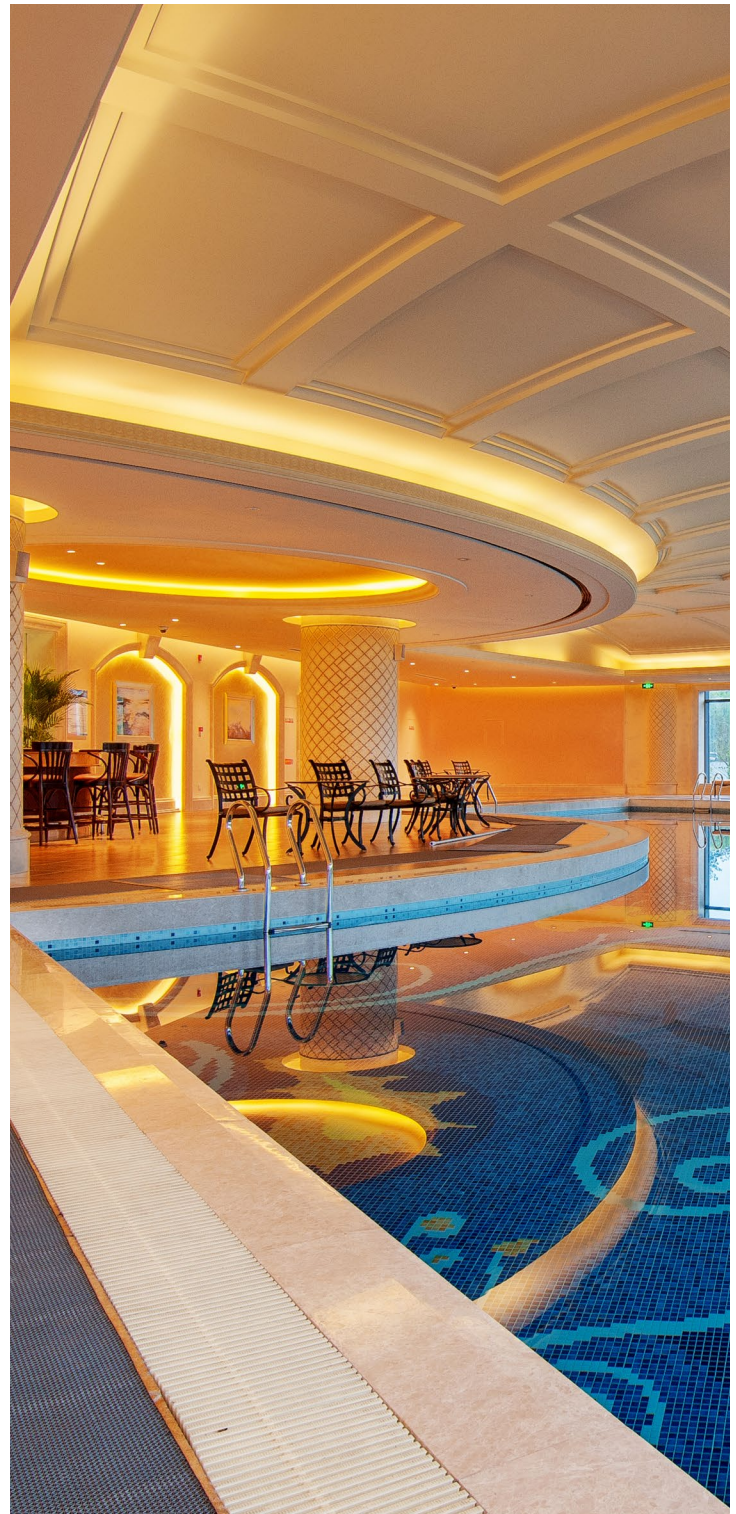

2700K CRI 100



2700K CRI 90



2700K CRI 80



2700K CRI 70

Classical Series

High Efficacy | High Density

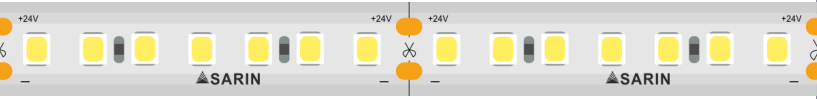

High Efficacy High Density

SARIN’s Classical Series LED Strip Lights are flexible lengths of light that can be used almost anywhere. These lights are safe for outdoor use and protected from rain, snow, and weak jets of water, such as sprinklers. These strip lights come in three color temperatures.

The Classical Strip Light is cuttable every 2 inches, allowing for customizable length. Mix-and-match accessories make these lights versatile and perfect for almost any application from grocery store shelving to residential accent lighting. Strong 3M tape makes mounting simple and durable. 5 year warranty!

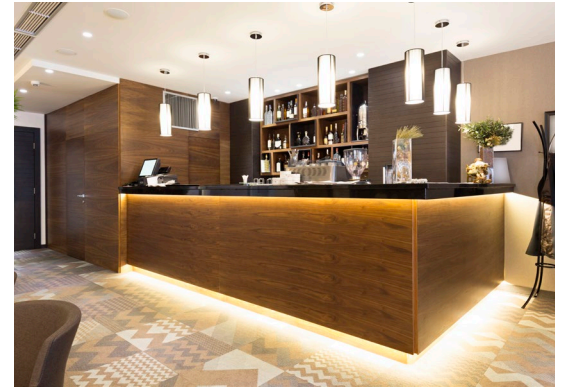

Item Code	Model Number
51004	SES - SLL - 65 - 3000
51006	SES - SLL - 65 - 4000
51007	SES - SLL - 65 - 5700

TECHNICAL SPECIFICATIONS

Watts	14.4 Watts/Meter		
Lumens	3500 Lumens/Meter		
Size	16.4ft(5M)/Roll, 10mm PCB Width	CCT	3000K 4000K 5700K
Voltage	24V	IP Rating	IP65
Dimmable	Yes	Materials	Silicone Tubing / PCB
Beam Angle	120°	Finish	Clear/White
CRI	>80	Density	160LED/Meter
		Lifespan	50,000 hours

Classical Series

High CRI

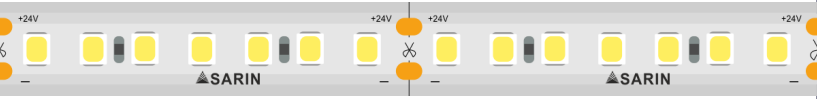

High CRI

SARIN's High CRI Classical Series LED Strip Lights are perfect for when you need high efficacy and high density lights that show your subject's true colors. These lights are IP65 rated and are safe for outdoor use and protected from rain, snow, and weak jets of water, such as sprinklers.

The Classical Strip Light is cuttable every 2 inches, allowing for customizable length. Mix-and-match accessories make these lights versatile and perfect for almost any application from grocery store shelving to residential accent lighting. Strong 3M tape makes mounting simple and durable. 5 year warranty!



Item Code	Model Number
51005	SES - SLL-CRI - 65-3000

TECHNICAL SPECIFICATIONS

Watts	14 Watts/Meter
Lumens	3500 Lumens/Meter

Size	16.4ft(5M)/Roll, 10mm PCB Width	CCT	3000K
Voltage	24V	IP Rating	IP65
Dimmable	Yes	Materials	Silicone Tubing / PCB
Beam Angle	120°	Finish	Clear/White
CRI	>90	Density	160LED/Meter
		Lifespan	50,000 hours

Ultra Long Series

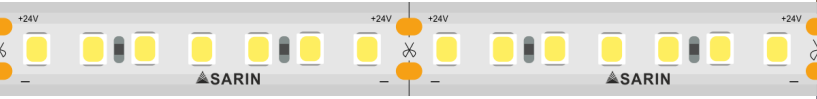

Ultra Long

SARIN's Ultra Long Led Strip lights are 65ft long, allowing for large applications without loss of brightness. These lights are IP67 rated and are safe for outdoor use and protected from rain, snow, and weak jets of water, such as sprinklers. These strips come in two color temperatures.

The ultra long series is cuttable every 1½ inches, allowing for customizable length. Mix-and-match accessories make these lights versatile and perfect for almost any application. Strong 3M tape makes mounting simple and durable. 5 year warranty!



Item Code	Model Number
51008	SES-SLL-UL-67-3000
51009	SES-SLL-UL-67-5000

TECHNICAL SPECIFICATIONS

CCT	3000K	5000K		
Watts	11W/M	11W/M		
Lumens	690lm/M	730lm/M		
Size	65.6ft(20M)/Roll, 10mm PCB Width		CCT	3000K 5000K
Voltage	24V		IP Rating	IP67
Dimmable	Yes		Materials	Silicone Extrusion / PCB
Beam Angle	120°		Finish	Clear/White
CRI	>80		Density	120LED/Meter
			Lifespan	50,000 hours

CCT Tunable Series

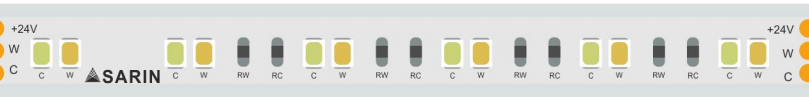

CCT Tunable

SARIN's CCT tunable series is a versatile strip light with customizable color temperatures. These lights are IP67 rated and are safe for outdoor use and protected from rain, snow, and weak jets of water, such as sprinklers.

CCT tunable strips lights are cuttable every 4 inches, allowing for customizable length. Mix-and-match accessories make these lights versatile and perfect for almost any application. Strong 3M tape makes mounting simple and durable. 5 year warranty!



Item Code	Model Number
51010	SES - SLL- 65 - CCT

TECHNICAL SPECIFICATIONS

Watts	14.4 Watts/Meter		
Lumens	1225 Lumens/Meter		
Size	16.4ft(20M)/Roll, 10mm PCB Width	 CCT	(2700K-6500K)
Voltage	24V	IP Rating	IP67
Dimmable	Yes	Materials	Silicone Tubing / PCB
Beam Angle	120°	Finish	Clear/White
CRI	>80	Density	120LED/Meter
		Lifespan	50,000 hours

RBGWW Tunable



RGBWW Tunable

SARIN's high quality RGBWW strip lights are incredibly versatile, allowing you to make custom color temperatures to match any set up. These lights are IP65 rated and safe outdoor use and protected from rain, snow, and weak jets of water, such as sprinklers.

The RGBWW strip is cuttable every 6 ½ inches, allowing you to customize the length and shape to your liking. Mix-and-match accessories make these lights versatile and perfect for almost any application. Strong 3M tape makes mounting simple and durable. 5 year warranty!



Item Code	Model Number
51011	SES - SLL- 65 - RGBWW

TECHNICAL SPECIFICATIONS

Watts	14.4 Watts/Meter		
Lumens	820 Lumens/Meter		
Size	16.4ft(5M)/Roll, 15mm PCB Width	CCT	RGBWW (2700K - 6500K)
Voltage	24V	IP Rating	IP65
Dimmable	Yes	Materials	Silicone Tubing / PCB
Beam Angle	120°	Finish	Clear/White
CRI	>80	Density	180LED/Meter
		Lifespan	50,000 hours

White Flex Sheet

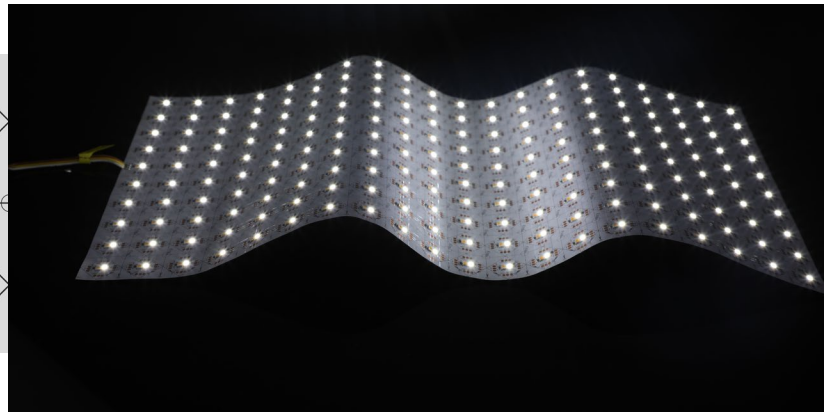
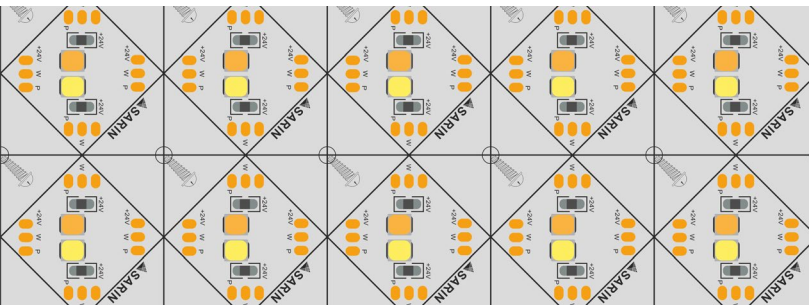

White Flex Sheet

SARIN's Tunable White Flex Sheet is a high-end solution for creating an even flow of light. The flex sheet has a custom cuttable size to make the application process flexible. The light is IP54 rated and has custom tunable CCT of 2700K-6500K.

The flex sheet is a versatile light that can be used to make multiple shapes such as linear, square, rectangle, donut, L, and T shapes. Super-strong 3M tape makes mounting simple and durable. 5 year warranty!



Item Code	Model Number
51003	SES - SLL - 54 - CCT

TECHNICAL SPECIFICATIONS

Watts	90 Watts/Sheet		
Lumens	7500 Lumens/Sheet		
Size	18.9" X 9.4"	 CCT	(2700K-6500K)
Voltage	24V	IP Rating	IP54
Dimmable	Yes	Materials	Nano Coated PCB
Beam Angle	120°	Finish	White
CRI	>80	Density	400LED/Sheet
PF	>0.9	Lifespan	50,000 hours



RGBW Flex Sheet

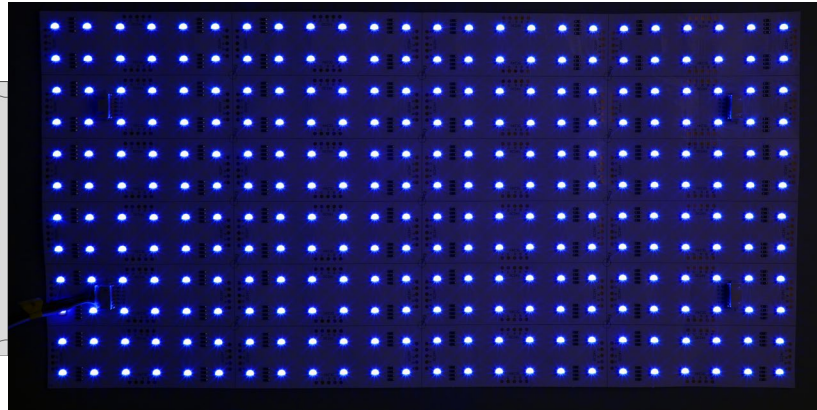
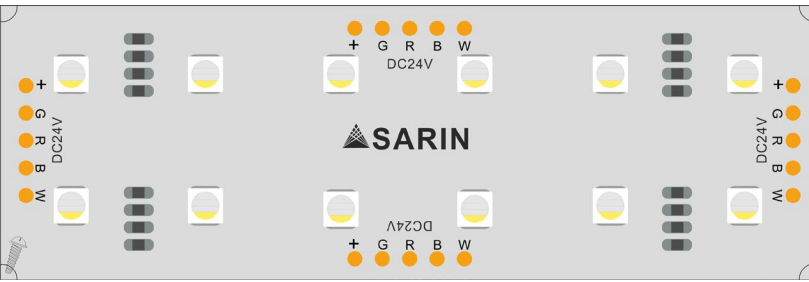

RGBW Flex Sheet

SARIN’s RGBW 4in1 Flex Sheet is a high-end solution for creating an even flow of light. The flex sheet has a custom cuttable size to make the application process flexible. The light is IP54 rated and has a custom color temperature to match any setup.

The flex sheet is a versatile light that can be used to make multiple shapes such as linear, square, rectangle, donut, L, and T shapes. Super-strong 3M tape makes mounting simple and durable. 5 year warranty!



Item Code	Model Number
51001	SES - SLL - 54 - RGBW

TECHNICAL SPECIFICATIONS

Watts	90 Watts/Sheet		
Lumens	4240 Lumens/Sheet		
Size	18.9" X 9.4"	CCT	RGBW (2700K)
Voltage	24V	IP Rating	IP54
Dimmable	Yes	Materials	Nano Coated PCB
Beam Angle	120°	Finish	White
CRI	>80	Density	288LED/Sheet
PF	>0.9	Lifespan	50,000 hours

Slim Light Strip

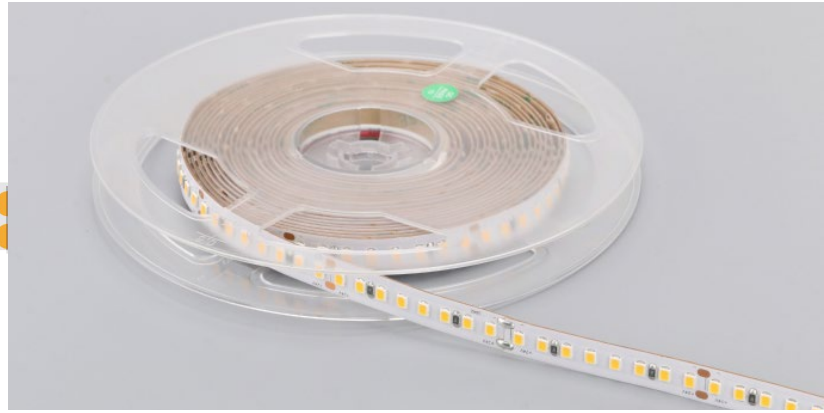

Slim Light Strip

SARIN's Slim Strip Lights are 5mm lights that are perfect for applications in tight spaces, including underneath cabinets. These lights can easily be hidden due to their small size. With 160 LEDs per Meter, SARIN's Slim Strip Lights put out more Lumens than strips twice their size..

The Slim Strip Light is cuttable every 2 inches, allowing for customizable length. Mix-and-match accessories make these lights more versatile. Strong 3M VHB tape makes mounting simple and durable. 5 year warranty!



Item Code	Model Number
51013	SES - HDSL - 2700 - 14.4

TECHNICAL SPECIFICATIONS

Watts	14.4 Watts/Meter		
Lumens	1780 Lumens/Meter		
Size	16.4ft(5M)/Roll, 5mm PCB Width	CCT	2700K
Voltage	24V	IP Rating	IP20
Dimmable	Yes	Materials	PCB
Beam Angle	120°	Finish	White
CRI	>90	Density	160LED/Meter
	Lifespan	50,000 hours	

COB Strip Light



Continuous Strip light

SARIN's COB light is a high density, high CRI and quality constant light with no dark spots. It has an IP67 rating and is safe for outdoor use and protected from rain, snow, and weak jets of water, such as sprinklers.

With 480 LEDs per Meter, the COB light is a strip light of the highest quality. It will bring life to any space. It's cuttable every 2 inches allowing for customizable length. Mix-and-match accessories make these lights versatile and perfect for almost any application. Strong 3M VHB tape makes mounting simple and durable. 5 year warranty!



Item Code	Model Number
51014	SES - HDSL - 2700 - 12

TECHNICAL SPECIFICATIONS

Watts	12 Watts/Meter		
Lumens	1080 Lumens/Meter		
Size	16.4ft(5M)/Roll, 10mm PCB Width	CCT	2700K
Voltage	24V	IP Rating	IP67
Dimmable	Yes	Materials	Silicone Extrusion / PCB
Beam Angle	120°	Finish	White
CRI	>90	Density	480LED/Meter
	Lifespan	50,000 hours	

CSP Strip Light

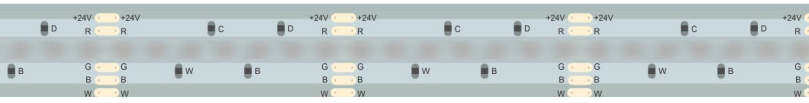

Continuous Strip light

SARIN’s CSP light is a high density high quality constant light with no dark spots. It has an IP67 rating and is safe for outdoor use and protected from rain, snow, and weak jets of water, such as sprinklers. Being RGBW you can customize your lights to fit any set up.

The CSP light is a strip light of the highest quality, bringing life to any space. It’s cuttable every 1 ½ inches, allowing for customizable length. Mix-and-match accessories make these lights versatile and perfect for almost any application. Strong 3M VHB tape makes mounting simple and durable. 5 year warranty!



Item Code	Model Number
51015	SES - HDSL - RGBW - 20

TECHNICAL SPECIFICATIONS

Watts	20 Watts/Meter		
Lumens	860 Lumens/Meter		
Size	16.4ft(5M)/Roll, 12mm PCB Width	CCT	RGBW (2700K)
Voltage	24V	IP Rating	IP67
Dimmable	Yes	Materials	Silicone Extrusion / PCB
Beam Angle	120°	Finish	White
CRI	>90	Density	840LED/Meter
	Lifespan	50,000 hours	

Flex Strip Light Kit

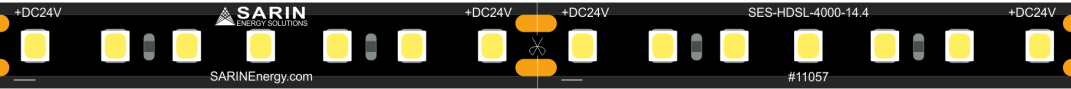

Strip Light Kit

SARIN's LED Flex Kits are the perfect all in one solution for hassle free lighting. Each kit comes with all you need to step up from the driver to the mounting accessories. For more custom jobs you can also purchase additional accessories to fit any job.

The Flex Kits are high quality strip lights that are IP65 rated and is safe for outdoor use. Being cuttable every 2 ½ inches these kits are perfect for almost any application. 5 year warranty!



Item Code	Model Number
11056	SES - HDSL-3000-14.4
11057	SES - HDSL-4000-14.4
11058	SES - HDSL-5000-14.4
51012	SES - HDSL-3000-7.2

TECHNICAL SPECIFICATIONS

Watts	14.4W/M	14.4W/M	14.4W/M	7.2W/M
Lumens	1450lm/M	1500lm/M	1510lm/M	800lm/M
CCT	3000K	4000K	5000K	3000K
Size	15ft(5M)/Roll, 10mm PCB Width			
Voltage	24V		IP Rating	IP65 (Water Resistant)
Dimmable	Yes		Materials	Silicone Tubing
Beam Angle	120°		Finish	Clear
CRI	>80		Lifespan	50,000 hours

RGBW Flex Strip Light



RGBW Strip Light Kit

SARIN's LED Flex Kits are the perfect all in one solution for hassle free lighting. Each kit comes with all you need to step up from the driver to the mounting accessories. For more custom jobs you can also purchase additional accessories to fit any job.

The Flex Kits are high quality strip lights that are IP65 rated and is safe for outdoor use. Being cuttable every 2 ½ inches these kits are perfect for almost any application. 5 year warranty!



Item Code	Model Number
-----------	--------------

11059	SES - HDSL-RGBW-14.4
-------	----------------------

TECHNICAL SPECIFICATIONS

Watts	14.4 Watts/Meter		
Lumens	500 Lumens/Meter		
Size	16.4ft(5M)/Roll, 10mm PCB Width	CCT	RGBW + 2700K
Voltage	24V	IP Rating	IP65
Dimmable	Yes	Materials	Silicone Tubing / PCB
Beam Angle	120°	Finish	Black
CRI	>80	Density	120LED/Meter
		Lifespan	50,000 hours

Inspire with **SARIN**



2022 LED Strip Light Catalog



 855-997-2746  LED@SARINEnergy.com  SARINEnergy.com